



COMPONENTS

FLAT PACK











PLOCHÉ BALENÍ / FLAT PACK





COMPONENTS

OBSAH / CONTENTS



Samonosné stolové rámy a podnože / Self-supporting metal frames and bases

	6	I-BASE
	10	I-BASE MOVE
	12	A-BASE
	14	U-BASE
	16	BASIC & BASIC PLUS
	18	FTU
	20	FTU CONFERENCE
	24	FTM
	26	FTT
	28	CUBIC
	32	MOVE







Skládací stolové podnože / Folding table frames

	36	EASY FBF
	38	EASY FBX





Univerzální stolové nohy / Multi-purpose table legs

	40	SIMPLE
	42	SOLID
	45	PURE & SPILE

Kovové příslušenství / Metal accessories

PC nosič / CPU holder SINGLE	46	
PC nosič / CPU holder CUBIC	47	
PC nosič / CPU holder CONCEPT	48	
Kabelové kanály / cable channels TUNNEL	50	
Perforované clony / perforated metal screens SLIM & SHIELD	52	
Stolové paravány s příslušenstvím / desk partitions incl. accessories FABRIC	54	

Plastové příslušenství / Plastic accessories

Výsuv na klávesnici / keyboard tray	56	
Systém vedení kabelů / cabling system	57	
Kabelové klipy / cable clips	58	
Ostatní / others	59	

Plastové židle / Plastic chairs

KALI	60	
VICENZA	63	

I-BASE

STOLOVÁ PODNOŽ / DESK BASE



I-BASE

STOLOVÁ PODNOŽ / DESK BASE

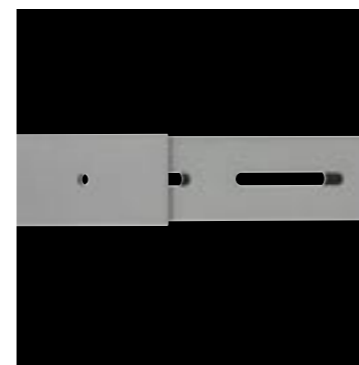
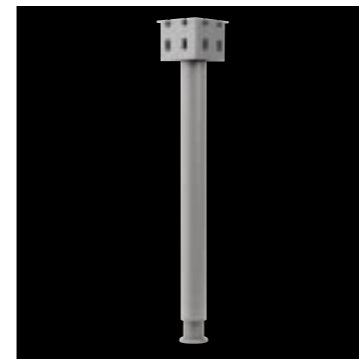

stolová podnož / desk base I-BASE

pro délku stolu / for the desk length 1000 - 1420 mm
F1IB69006 (5) hloubka stolu / desk depth 600 mm
F1IB89006 (5) hloubka stolu / desk depth 800 mm

pro délku stolu / for the desk length 1450 - 2300 mm
F2IB69006 (5) hloubka stolu / desk depth 600 mm
F2IB89006 (5) hloubka stolu / desk depth 800 mm

ergo pracoviště / corner workstation
FIB9006 (5) ergo pracoviště / corner workstation

Výrobky jsou dodávány v barevném provedení /
products are delivered in the following finishes:
hliník struktura / aluminium structure RAL9006
černá struktura / black structure RAL9005



I-BASE MOVE

VÝŠKOVĚ STAVITELNÁ PODNOŽ /
HEIGHT ADJUSTABLE BASE



stolové podnože / desk bases I-BASE MOVE

pro délku stolu / for the desk length 1000 - 1420 mm
F11BE69006 (5) hloubka stolu / desk depth 600 mm
F11BE89006 (5) hloubka stolu / desk depth 800 mm

pro délku stolu / for the desk length 1450 - 2300 mm
F21BE69006 (5) hloubka stolu / desk depth 600 mm
F21BE89006 (5) hloubka stolu / desk depth 800 mm

Výrobky jsou dodávány v barevném provedení /
products are delivered in the following finishes:
hliník struktura / aluminium structure RAL9006
černá struktura / black structure RAL9005



A-BASE

STOLOVÁ PODNOŽ / DESK BASE



stolová podnož / desk base A-BASE

pro délku stolu / for the desk length 1000-1420 mm
F1AB9006 (5) hloubka stolu / desk depth 800 mm

pro délku stolu / for the desk length 1450-2300 mm
F2AB9006 (5) hloubka stolu / desk depth 800 mm

Výrobky jsou dodávány v barevném provedení /
products are delivered in the following finishes:
hliník struktura / aluminium structure RAL9006
černá struktura / black structure RAL9005



U-BASE

STOLOVÁ PODNOŽ / DESK BASE



stolová podnož / desk base U-BASE

pro délku stolu / for the desk length 960 - 1380 mm
F1UB89006 (5) hloubka stolu / desk depth 800 mm

pro délku stolu / for the desk length 1420 - 2270 mm
F2UB89006 (5) hloubka stolu / desk depth 800 mm

Výrobky jsou dodávány v barevném provedení /
products are delivered in the following finishes:
hliník struktura / aluminium structure RAL9006
černá struktura / black structure RAL9005

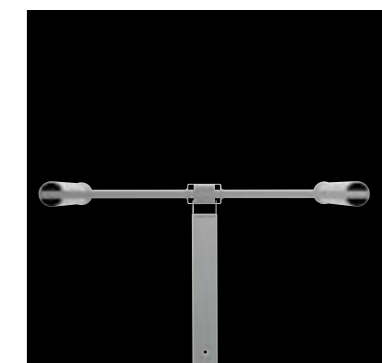
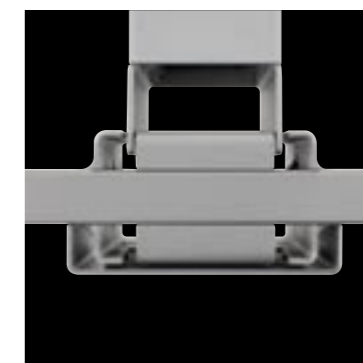

BASIC & BASIC PLUS

STOLOVÉ PODNOŽE / METAL BASES



stolové nohy / desk legs BASIC

R69006 (5) hloubka stolu / desk depth 600 mm
R89006 (5) hloubka stolu / desk depth 800 mm

stolové podnože / desk bases BASIC PLUS

pro délku stolu / for the desk length 1000 - 1420 mm
F1R69006 (5) hloubka stolu / desk depth 600 mm
F1R89006 (5) hloubka stolu / desk depth 800 mm

pro délku stolu / for the desk length 1450 - 2300 mm
F2R69006 (5) hloubka stolu / desk depth 600 mm
F2R89006 (5) hloubka stolu / desk depth 800 mm

boční kryty / side covers

MC9006 (5)
MCP9006 (5)
MCC9006 (5)

ergo pracoviště / corner workstation

FRC9006 (5) ergo pracoviště / corner workstation

Výrobky jsou dodávány v barevném provedení /
products are delivered in the following finishes:
hliník struktura / aluminium structure RAL9006
černá struktura / black structure RAL9005

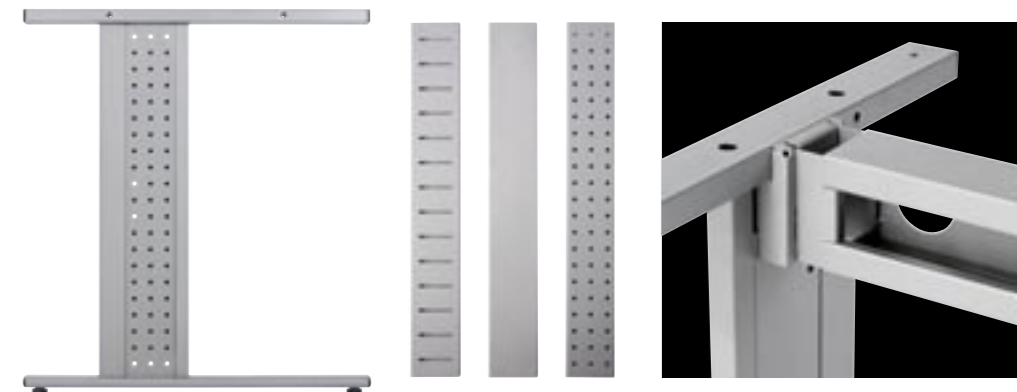

FTU

RÁMOVÉ PODNOŽE / TABLE FRAMES



rámové podnože / table frames FTU

pro hloubku stolu / for the desk depth 600 mm

- FTU06066 (5) délka / length 600 mm
- FTU08066 (5) délka / length 800 mm
- FTU10066 (5) délka / length 1000 mm
- FTU12066 (5) délka / length 1200 mm
- FTU14066 (5) délka / length 1400 mm
- FTU15066 (5) délka / length 1500 mm
- FTU16066 (5) délka / length 1600 mm
- FTU18066 (5) délka / length 1800 mm
- FTU20066 (5) délka / length 2000 mm

pro hloubku stolu / for the desk depth 800 mm

- FTU08086 (5) délka / length 800 mm
- FTU10086 (5) délka / length 1000 mm
- FTU12086 (5) délka / length 1200 mm
- FTU14086 (5) délka / length 1400 mm
- FTU15086 (5) délka / length 1500 mm
- FTU16086 (5) délka / length 1600 mm
- FTU18086 (5) délka / length 1800 mm
- FTU20086 (5) délka / length 2000 mm

Výrobky jsou dodávány v barevném provedení /
products are delivered in the following finishes:
hliník struktura / aluminium structure RAL9006
černá struktura / black structure RAL9005







Výrobky jsou dodávány v barevném provedení /
products are delivered in the following finishes:
hliník struktura / aluminium structure RAL9006
černá struktura / black structure RAL9005

příklady sestav / conference tables example

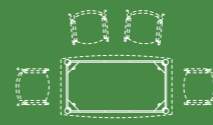

FCUKF066 (5)

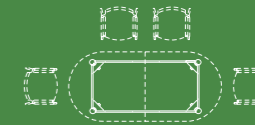

FCUOF066 (5)



FCUKF086 (5)

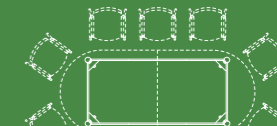

FCUOF106 (5)

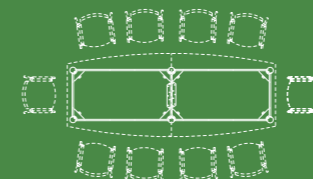

FCUKF106 (5)

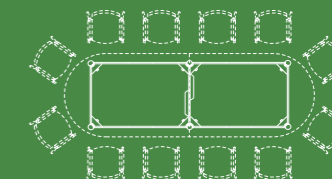

FCUOF126 (5)

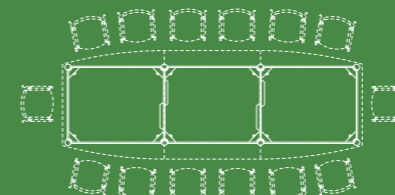

FCUKF146 (5)

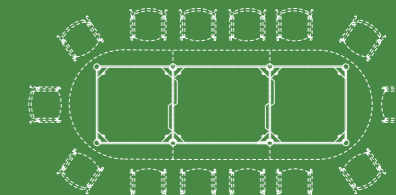

FCUOF146 (5)

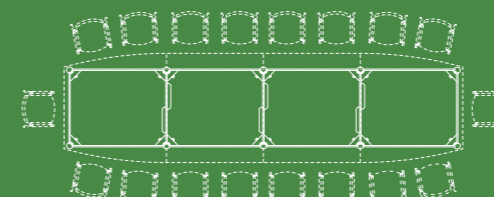

FCUKF186 (5)

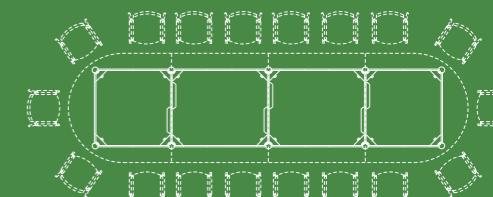

FCUOF186 (5)

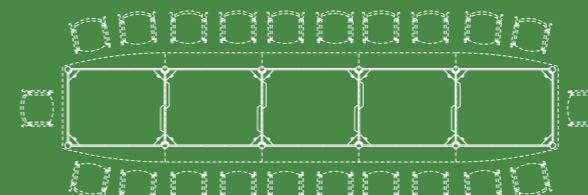

FCUKF226 (5)

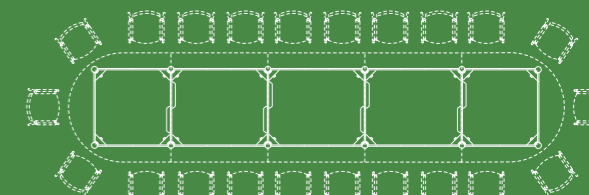

FCUOF226 (5)

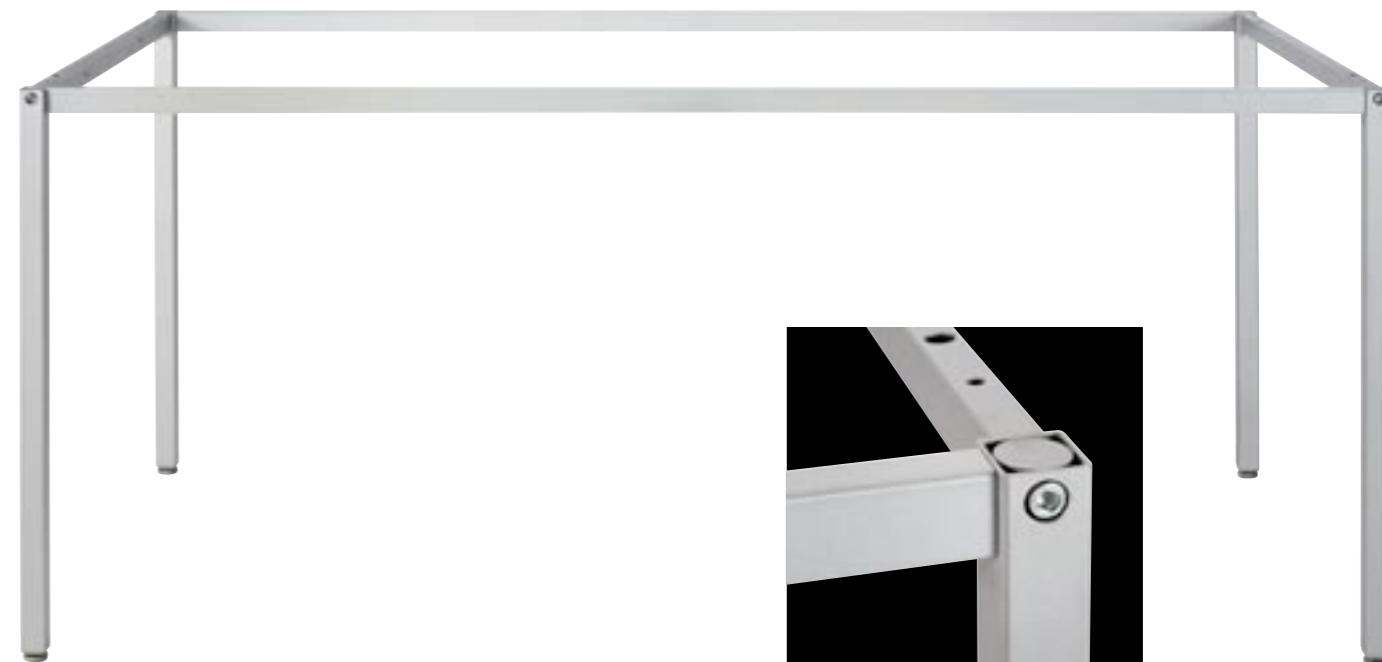

rámové podnože / table frames FTM

pro hloubku stolu / for the desk depth 600 mm

FTM06066 (5) délka / length 600 mm
 FTM08066 (5) délka / length 800 mm
 FTM10066 (5) délka / length 1000 mm
 FTM12066 (5) délka / length 1200 mm
 FTM14066 (5) délka / length 1400 mm
 FTM16066 (5) délka / length 1600 mm
 FTM18066 (5) délka / length 1800 mm
 FTM20066 (5) délka / length 2000 mm

pro hloubku stolu / for the desk depth 800 mm

FTM08086 (5) délka / length 800 mm
 FTM10086 (5) délka / length 1000 mm
 FTM12086 (5) délka / length 1200 mm
 FTM14086 (5) délka / length 1400 mm
 FTM16086 (5) délka / length 1600 mm
 FTM18086 (5) délka / length 1800 mm
 FTM20086 (5) délka / length 2000 mm

Výrobky jsou dodávány v barevném provedení /
 products are delivered in the following finishes:
 hliník struktura / aluminium structure RAL9006
 černá struktura / black structure RAL9005



RÁMOVÁ PODNOŽ / TABLE FRAME



FTT16086 rámová podnož / table frame 1600 x 800 mm

Výrobky jsou dodávány v barevném provedení /
products are delivered in the following finishes:
hliník struktura / aluminium structure RAL9006

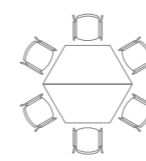

6 ě

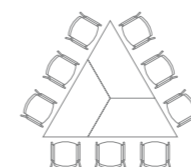

9 ě

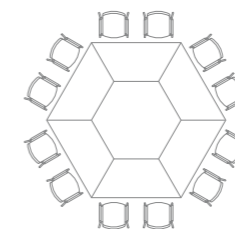

12 ě

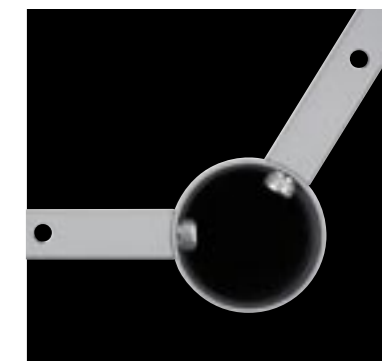

CUBIC

KANCELÁŘSKÝ SYSTÉM / OFFICE SYSTEM



kancelářský systém / office system CUBIC

základní rám pro hloubku /
basic desk frame for the depth 896 mm

FCD096	délka / length	896 mm
FCD126	délka / length	1196 mm
FCD146	délka / length	1396 mm
FCD166	délka / length	1596 mm
FCD186	délka / length	1796 mm
FCD206	délka / length	1996 mm
FCD226	délka / length	2196 mm
FCD246	délka / length	2396 mm

Výrobky jsou dodávány v barevném provedení /
products are delivered in the following finishes:
hliník struktura / aluminium structure RAL9006



CUBIC

KANCELÁŘSKÝ SYSTÉM / OFFICE SYSTEM

příklad spojení stolů do nekonečných řad /
endless line desks connection – illustration of application

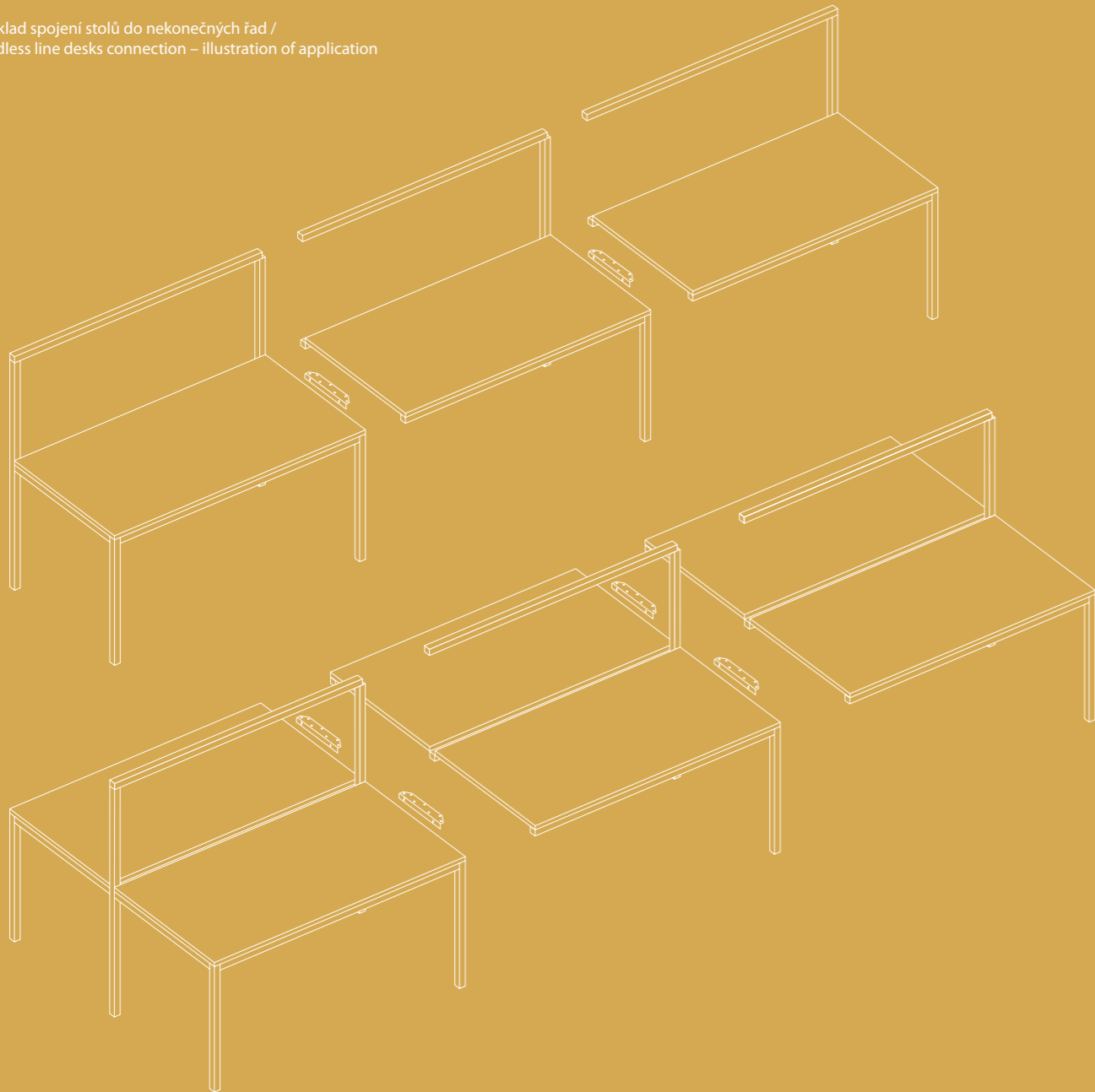

příklady sestav / workstation's example

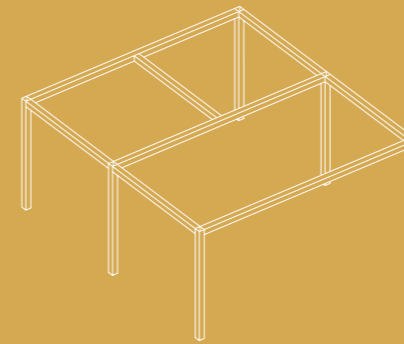

FCDD186

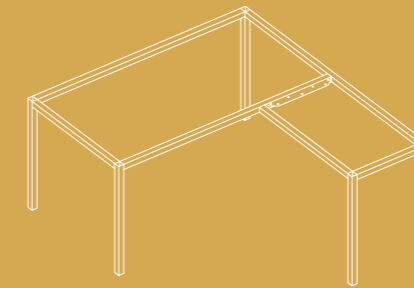

FCDL186

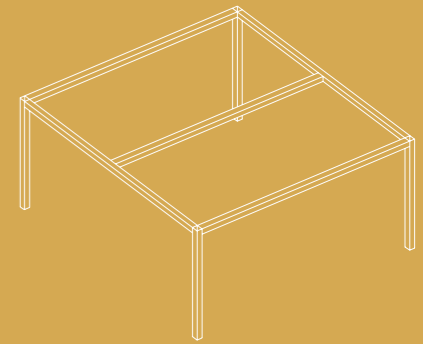

FCDC2020

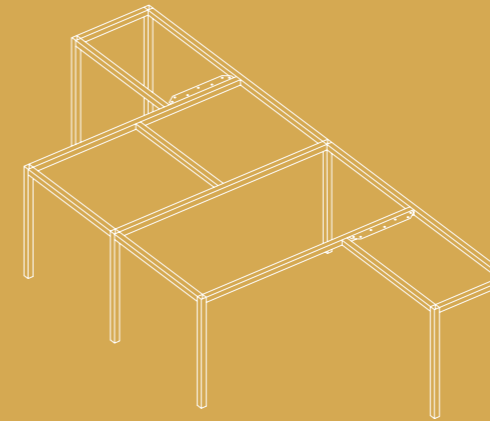

FCDT186

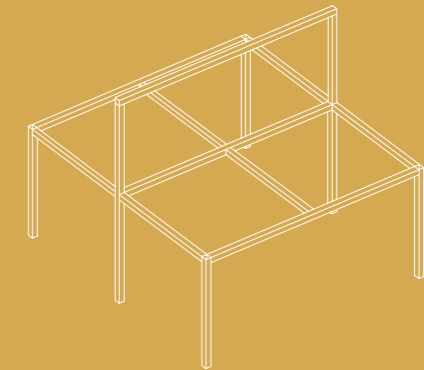

FCDDP186

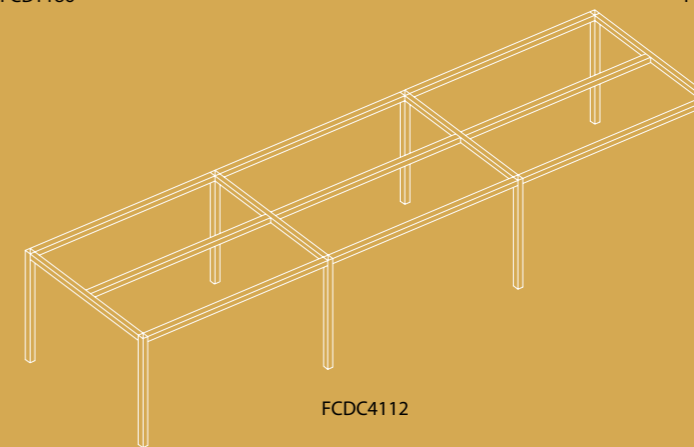

FCDC4112

MOVE

VÝŠKOVĚ STAVITELNÁ PODNOŽ /
HEIGHT-ADJUSTABLE BASE



výškově stavitelné podnože / height-adjustable bases MOVE

**manuálně stavitelná stolová podnož /
manually adjustable desk base**

FTH21 výšková stavitelnost / height adjustability 695 - 1115 mm

**elektricky stavitelná stolová podnož /
power adjustable desk base**

FTE22 výšková stavitelnost / height adjustability 620 - 1270 mm

šířková stavitelnost pro oba typy /
width adjustability for both types 1100 - 1700 mm

Výrobky jsou dodávány v provedení /
products are delivered in the following finishes:
eloxovaný hliník / anodized aluminium



MOVE

VÝŠKOVĚ STAVITELNÁ PODNOŽ /
HEIGHT-ADJUSTABLE BASE



EASY FBF

SKLÁDACÍ PODNOŽ / FOLDING BASE

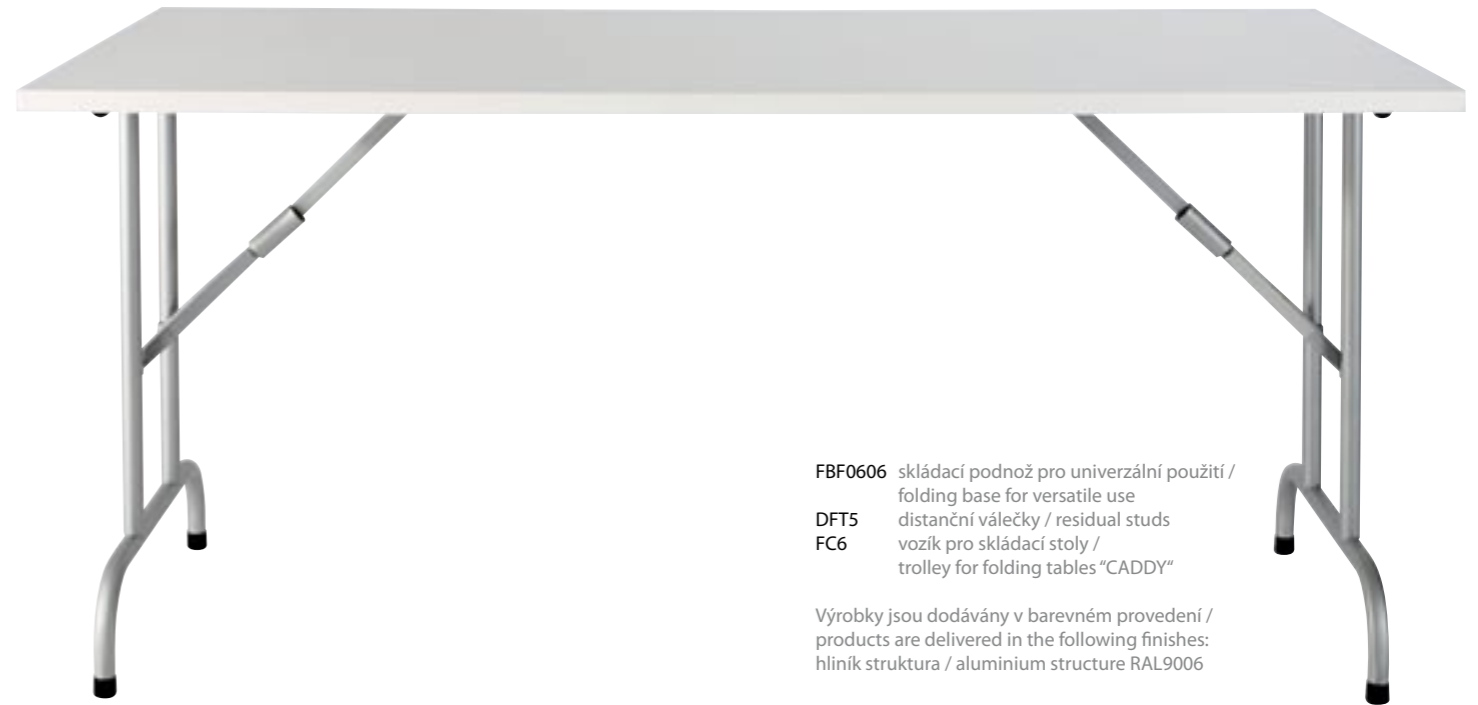

FBF0606 skládací podnož pro univerzální použití /
folding base for versatile use
DFT5 distanční válečky / residual studs
FC6 vozík pro skládací stoly /
trolley for folding tables "CADDY"

Výrobky jsou dodávány v barevném provedení /
products are delivered in the following finishes:
hliníková struktura / aluminium structure RAL9006

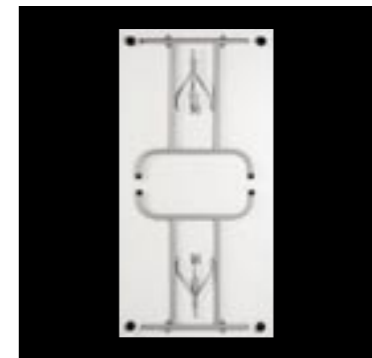

EASY FBX

SKLÁDACÍ PODNOŽ / FOLDING BASE



FBX skládací podnož pro univerzální použití /
folding base for versatile use

Výrobky jsou dodávány v barevném provedení /
products are delivered in the following finishes:
chróm / chrome



SIMPLE

DVOUKONZOLOVÁ NOHA / DOUBLE-KNEE LEG



stolová noha pro univerzální použití / table leg for versatile use

DKL9006 (5) výšková stavitelnost / height adjustability 80 mm

Výrobky jsou dodávány v barevném provedení /
products are delivered in the following finishes:
hliník struktura / aluminium structure RAL9006
černá struktura / black structure RAL9005



SOLID

CENTRÁLNÍ NOHY / CENTRAL LEGS



Centrální nohy / central legs SOLID

CLCA9006 (5), (X)	výška / height	480 mm, disk / bottom plate	447 mm
CLC9006 (5), (X)	výška / height	480 mm, disk / bottom plate	580 mm
CLAA9006 (5), (X)	výška / height	714 mm, disk / bottom plate	447 mm
CLA9006 (5), (X)	výška / height	714 mm, disk / bottom plate	580 mm
CLBA9006 (5), (X)	výška / height	1100 mm, disk / bottom plate	447 mm
CLB9006 (5), (X)	výška / height	1100 mm, disk / bottom plate	580 mm

Centrální nohy pro skleněnou desku / central legs for a glass top

CLCGA9006 (5), (X)	výška / height	460 mm, disk / bottom plate	447 mm
CLCG9006 (5), (X)	výška / height	460 mm, disk / bottom plate	580 mm
CLAGA9006 (5), (X)	výška / height	694 mm, disk / bottom plate	447 mm
CLAG9006 (5), (X)	výška / height	694 mm, disk / bottom plate	580 mm
CLBGA9006 (5), (X)	výška / height	1080 mm, disk / bottom plate	447 mm
CLBG9006 (5), (X)	výška / height	1080 mm, disk / bottom plate	580 mm

HP9 přidavné závaží pro disk /
additional heavy part for bottom plates
447 and 580 mm

Výrobky jsou dodávány v barevném provedení /
products are delivered in the following finishes:
hliník struktura / aluminium structure RAL9006
černá struktura / black structure RAL9005
chróm / chrome



Pro zvýšení stability stolu je možno použít přidavné závaží HP9. /
It is possible to use additional heavy part HP9 to increase the table stability.

SOLID

CENTRÁLNÍ NOHY / CENTRAL LEGS



PURE & SPILE

VÁLCOVÁ A ČTVERCOVÁ NOHA
ROUND AND SQUARE LEGS



RL9006 (5) válková noha / round leg
SL9006 čtvercová noha / square leg

Výrobky jsou dodávány v barevném provedení /
products are delivered in the following finishes:
hliník struktura / aluminium structure RAL9006
černá struktura / black structure RAL9005



SINGLE

PC NOSIČ/ CPU HOLDER



PCH9006 (5)
PC nosič s kruhovou perforací /
CPU holder with circular perforation

Výrobky jsou dodávány v barevném provedení /
products are delivered in the following finishes:
hliník struktura / aluminium structure RAL9006
černá struktura / black structure RAL9005

CUBIC

PC NOSIČ/ CPU HOLDER



PCHC9006
PC nosič s obdélníkovou perforací /
CPU holder with rectangular perforation

Výrobky jsou dodávány v barevném provedení /
products are delivered in the following finishes:
hliník struktura / aluminium structure RAL9006

CONCEPT

PC NOSIČ/ CPU HOLDER



otočný mechanismus /
rotary mechanism



PCHA9006

PC nosič s výsuvným a otočným mechanismem /
CPU holder with extensible and rotary mechanism

Výrobky jsou dodávány v barevném provedení /
products are delivered in the following finishes:
hliník struktura / aluminium structure RAL9006

výsuvný mechanismus /
extensible mechanism



TUNNEL

KABELOVÉ KANÁLY / CABLE CHANNELS



kabelové kanály / cable channels TUNNEL

CC0506 (5)	délka / length	500 mm
CC0706 (5)	délka / length	700 mm
CC0906 (5)	délka / length	900 mm
CC1106 (5)	délka / length	1100 mm
CC1306 (5)	délka / length	1300 mm
CC1506 (5)	délka / length	1500 mm

Výrobky jsou dodávány v barevném provedení /
products are delivered in the following finishes:
hliník struktura / aluminium structure RAL9006
černá struktura / black structure RAL9005

SLIM & SHIELD

KOVOVÉ CLONY / METAL SCREENS

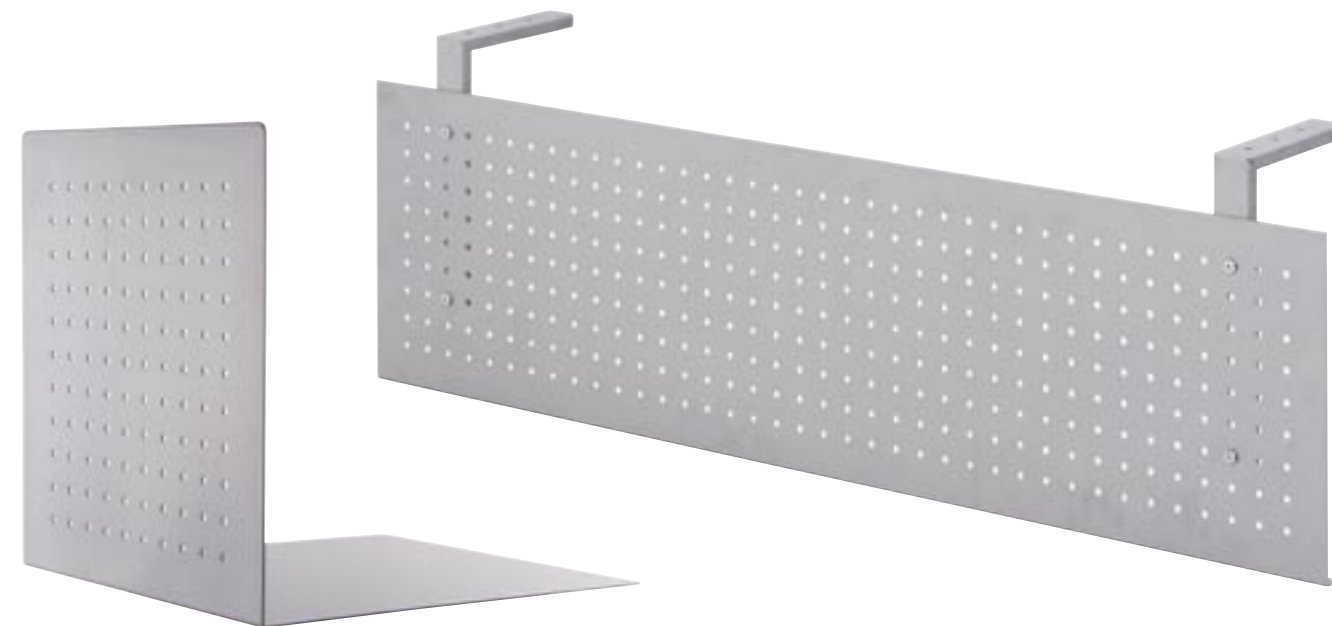

perforované kovové clony/ perforated metal screens

- CT0606 šířka / width 600 mm
- CT0806 šířka / width 800 mm
- CT1006 šířka / width 1000 mm
- CT1206 šířka / width 1200 mm
- CT1406 šířka / width 1400 mm
- CT1606 šířka / width 1600 mm

CM9006 clona monitoru / monitor screen

Výrobky jsou dodávány v barevném provedení /
products are delivered in the following finishes:
hliník struktura / aluminium structure RAL9006



FABRIC

STOLOVÉ PARAVÁNY / DESK PARTITION WALLS



stolové paravány / desk partition walls

FABRIC

BP08E (F), (M)	šířka / width 800 mm
BP10E (F), (M)	šířka / width 1000 mm
BP12E (F), (M)	šířka / width 1200 mm
BP14E (F), (M)	šířka / width 1400 mm
BP16E (F), (M)	šířka / width 1600 mm
BP17E (F), (M)	šířka / width 1700 mm
BP18E (F), (M)	šířka / width 1800 mm
BP24E (F), (M)	šířka / width 2400 mm

příslušenství / accessories

PFS9006	závěsná kovová policička / hanging metal shelf 310 x 250 mm
PFSB9006	závěsná kovová policička / hanging metal shelf 210 x 310 mm
PFPA4	závěsná plastová kapsa / hanging plastic pocket A4 225 x 250 mm
PFPA5	závěsná plastová kapsa / hanging plastic pocket A5 160 x 165 mm

Výrobky jsou dodávány v barevném provedení /
products are delivered in the following finishes:
Hliníkový rám s textilní výplní / aluminium frame with a textile fill
Potahová textilie E, F a M dle vzorníku sedacího nábytku /
Upholstery fabric E, F and M following the rating furniture fabrics swatch.



KEYBOARD TRAY

VÝSUV NA KLÁVESNICI/ KEYBOARD TRAY



KT - B9006 (5), (0)
výsuv na klávesnici / keyboard tray

Výrobky jsou dodávány v barevném provedení /
products are delivered in the following finishes:
hliník / aluminium
černá / black
transparentní / transparent



CSV9006 (5), (0) vertikální svod kabelů /
vertical cabling system
CSH9006 (5), (0) horizontální svod kabelů /
horizontal cabling system

Výrobky jsou dodávány v barevném provedení /
products are delivered in the following finishes:
hliník / aluminium
černá / black
transparentní / transparent

SYSTEM VEDENÍ KABELŮ / CABLING SYSTEM
CABLING SYSTEM

CABLE CLIPS

KABELOVÉ KLIPY / CABLE CLIPS

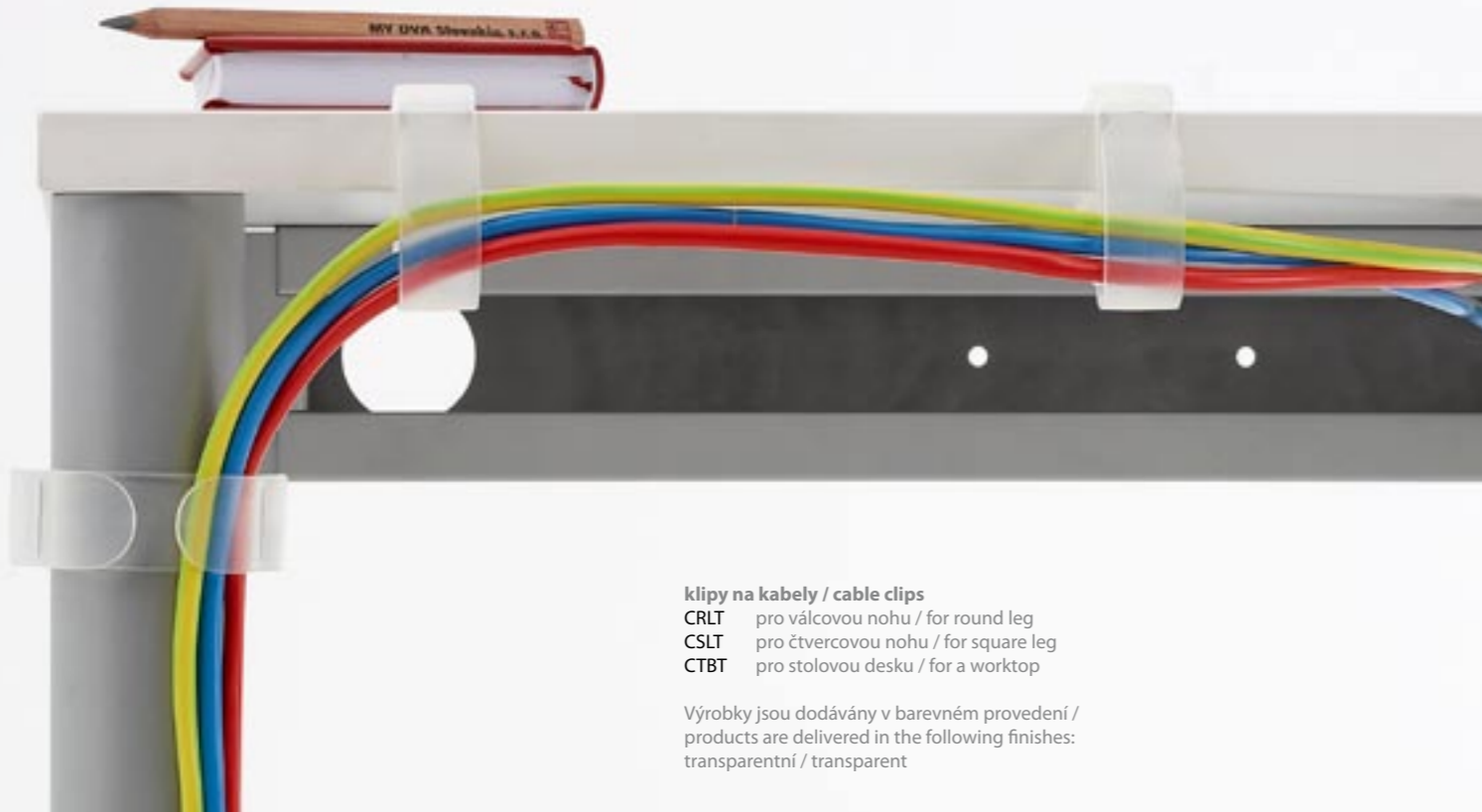

klipy na kabely / cable clips

- CRLT pro válcovou nohu / for round leg
- CSLT pro čtvercovou nohu / for square leg
- CTBT pro stolovou desku / for a worktop

Výrobky jsou dodávány v barevném provedení /
products are delivered in the following finishes:
transparentní / transparent



OTHERS

OSTATNÍ / OTHERS



- AP – B9006 (5) kabelová průchodka / cable passage
- AFF6 (5) plastová rektifikace pro válcovou nohu /
height adjustable plastic device for round leg
60 mm

Výrobky jsou dodávány v barevném provedení /
products are delivered in the following finishes:
hliník / aluminium
černá / black

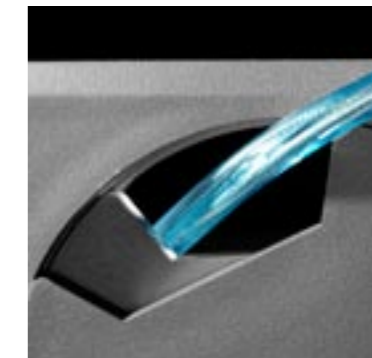

KALI

JÍDELNÍ ŽIDLE / DINING CHAIR



KALI

JÍDELNÍ ŽIDLE / DINING CHAIR

jídelní židle / dining chair KALI

CD90106 bílá / white
CD90176 černá / black
CD70116 antracit / antracite
CD70366 šedá / grey
CD10016 béžová / beige
CD264C6 fialová / violet
CD50036 modrá / blue
CD291C6 světle modrá / light blue
CD60046 zelená / green
CD361C6 jasně zelená / apple green
CD333C6 světle zelená / light green
CD30046 bordó / bordeaux
CD30206 červená / red
CD1505C6 oranžová / orange
CD10166 žlutá / yellow

Výrobky jsou dodávány v barevném provedení /
products are delivered in the following finishes:
Kovová kostra RAL9006 hliník /
metal frame RAL9006 aluminium
15 barevných odstínů /
15 colours of plastic parts



VICENZA

JÍDELNÍ ŽIDLE / DINING CHAIR

jídelní židle / dining chair VICENZA

CDBX modrá / blue
CDRX červená / red
CDYX žlutá / yellow
CDNX černá / black
CDWX bílá / white
CDGX šedá / grey
CDHX zelená / green
CDOX oranžová / orange

Výrobky jsou dodávány v barevném provedení /
products are delivered in the following finishes:
kovová kostra chróm / metal frame in chrome
8 barevných odstínů / 8 colours of plastic shell



VICENZA

JÍDELNÍ ŽIDLE / DINING CHAIR



barevné provedení / colour finishings



hliník struktura /
aluminium structure
RAL9006

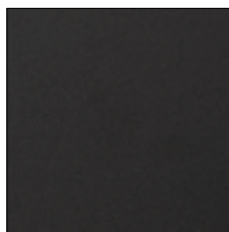

černá struktura /
black structure
RAL9005



chróm /
chrome

Zobrazené odstíny barev jsou pouze orientační a závisí na kvalitě tisku. /
Deviations in colour finishes are possible due to the printing process.

certifikáty / certificates



